

## PRODUCT FEATURES

- Ultrafast Recovery Time
- Low Recovery Loss
- Soft Reverse Recovery Characteristics
- Low Leakage Current
- Low Forward Voltage
- High Surge Current Capability

## APPLICATIONS

- Freewheeling, Snubber, Clamp
- Inversion Welder
- PFC
- Plating Power Supply
- Ultrasonic Cleaner and Welder
- Converter & Chopper
- UPS

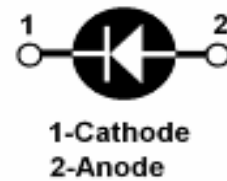
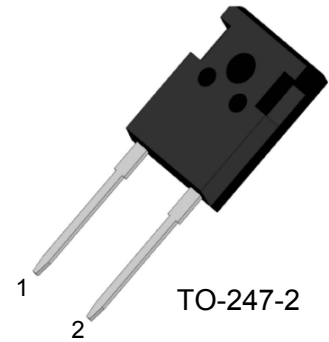

## DESCRIPTION

FRED from MacMic utilizes advanced processing techniques to achieve ultrafast recovery times and higher forward current. Its soft recovery characteristics and high reliability suit for wide industrial applications.

## ABSOLUTE MAXIMUM RATINGS ( $T_C=25^{\circ}\text{C}$ unless otherwise specified)

Symbol	Parameter/Test Conditions		Values	Unit
$V_R$	Maximum D.C. Reverse Voltage		1200	V
$V_{RRM}$	Maximum Repetitive Reverse Voltage			
$I_{F(AV)}$	Average Forward Current	$T_C=105^{\circ}\text{C}$	30	A
$I_{F(RMS)}$	RMS Forward Current	$T_C=105^{\circ}\text{C}$	42	
$I_{FSM}$	Non Repetitive Surge Forward Current	$T_J=25^{\circ}\text{C}, t=10\text{ms}, 50\text{Hz}, \text{Sine}$	280	
$P_D$	Power Dissipation		188	W
$T_J$	Junction Temperature		-55 to +175	$^{\circ}\text{C}$
$T_{STG}$	Storage Temperature Range		-55 to +150	$^{\circ}\text{C}$
Torque	To Heat Sink	Recommended (M3)	1.1	Nm
$R_{thJC}$	Junction to Case Thermal Resistance		0.8	$^{\circ}\text{C}/\text{W}$
Weight			6	g

## ELECTRICAL CHARACTERISTICS ( $T_C=25^{\circ}\text{C}$ unless otherwise specified)

Symbol	Parameter/Test Conditions		Min.	Typ.	Max.	Unit
$I_{RM}$	Maximum Reverse Leakage Current	$V_R = 1200\text{V}$			10	$\mu\text{A}$
		$V_R = 1200\text{V}, T_J = 150^{\circ}\text{C}$			500	
$V_F$	Forward Voltage	$I_F=30\text{A}$		2.8	3.5	V
		$I_F=30\text{A}, T_J=150^{\circ}\text{C}$		2.2		
trr	Reverse Recovery Time ( $I_F = 1\text{A}, di_F/dt = -200\text{A}/\mu\text{s}, V_R = 30\text{V}$ )			26	35	ns
trr	Reverse Recovery Time ( $I_F = 0.5\text{A}, I_R=1\text{A}, I_{RR} = 0.25\text{A}$ )			40	60	ns

MacMic Science & Technology Co., Ltd.

Add: #18, Hua Shan Zhong Lu, New District, Changzhou City, Jiangsu Province, P. R. of China

**ELECTRICAL CHARACTERISTICS** ( $T_C=25^{\circ}C$  unless otherwise specified)

Symbol	Parameter/Test Conditions	Min.	Typ.	Max.	Unit
$t_{rr}$	Reverse Recovery Time		250		ns
$I_{RRM}$	Maximum Reverse Recovery Current		5.5		A
$Q_{RR}$	Reverse Recovery Charge		600		nC
$t_{rr}$	Reverse Recovery Time		430		ns
$I_{RRM}$	Maximum Reverse Recovery Current		9.1		A
$Q_{RR}$	Reverse Recovery Charge		1850		nC
$t_{rr}$	Reverse Recovery Time		210		ns
$I_{RRM}$	Maximum Reverse Recovery Current		26		A
$Q_{RR}$	Reverse Recovery Charge		2760		nC

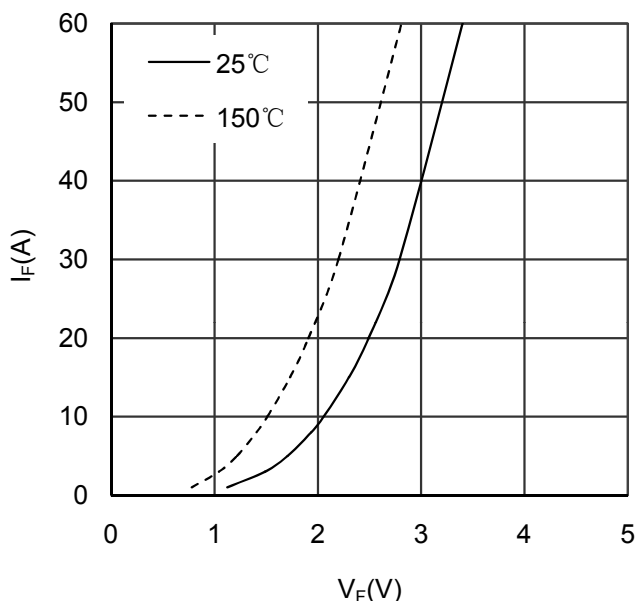

Figure 1. Forward Voltage Drop vs Forward Current

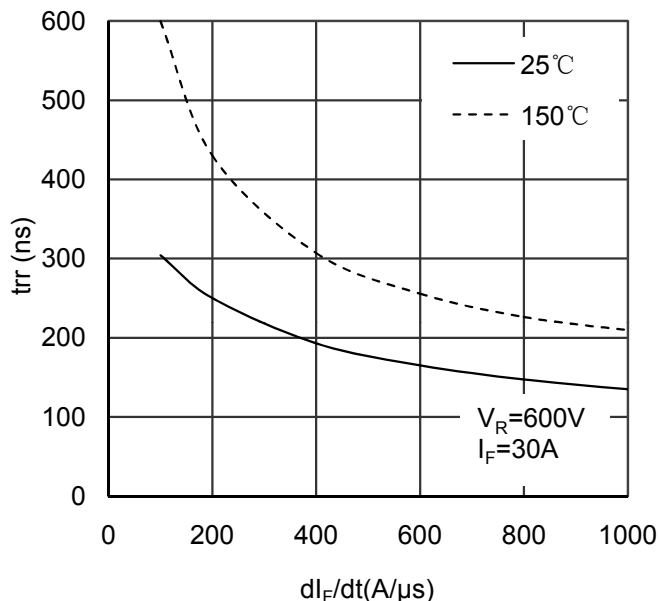

Figure 2. Reverse Recovery Time vs  $dI_F/dt$

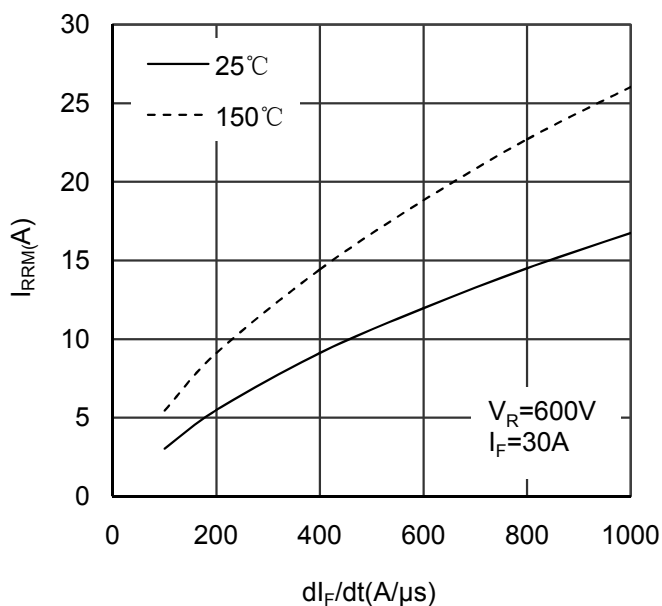

Figure 3. Reverse Recovery Current vs  $dI_F/dt$

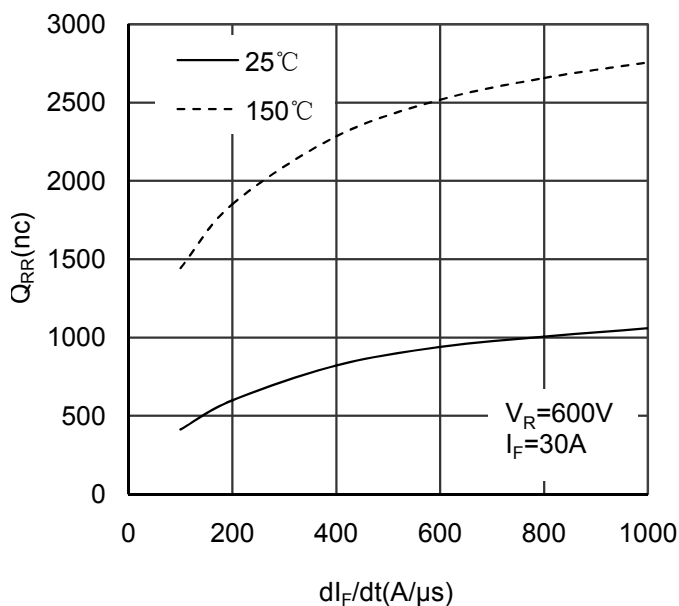

Figure 4. Reverse Recovery Charge vs  $dI_F/dt$

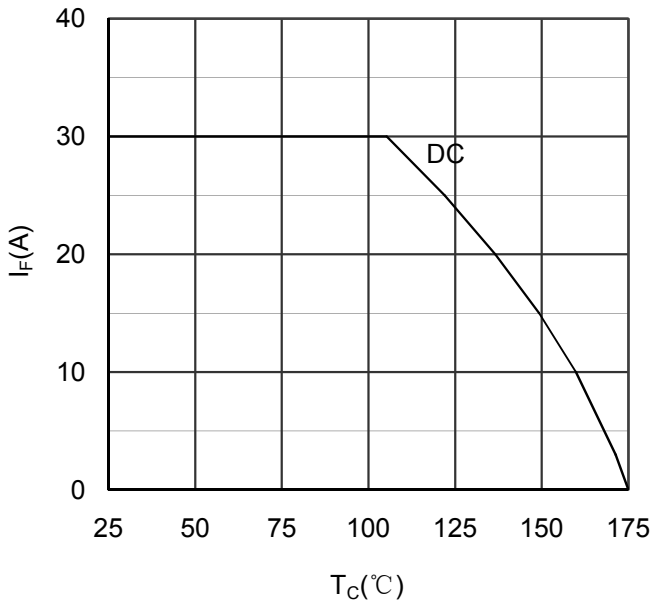

Figure 5. Forward current vs Case temperature

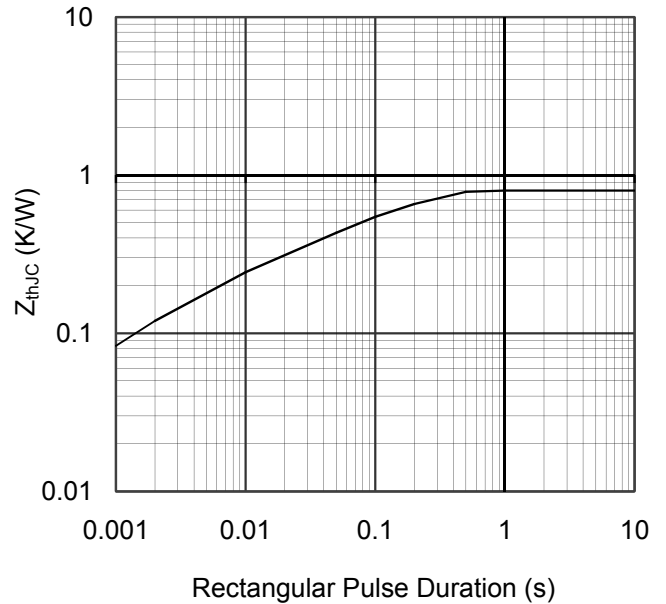

Figure 6. Transient Thermal Impedance

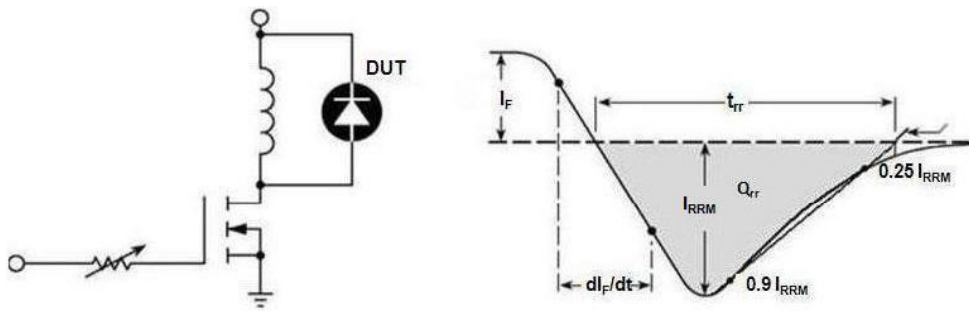
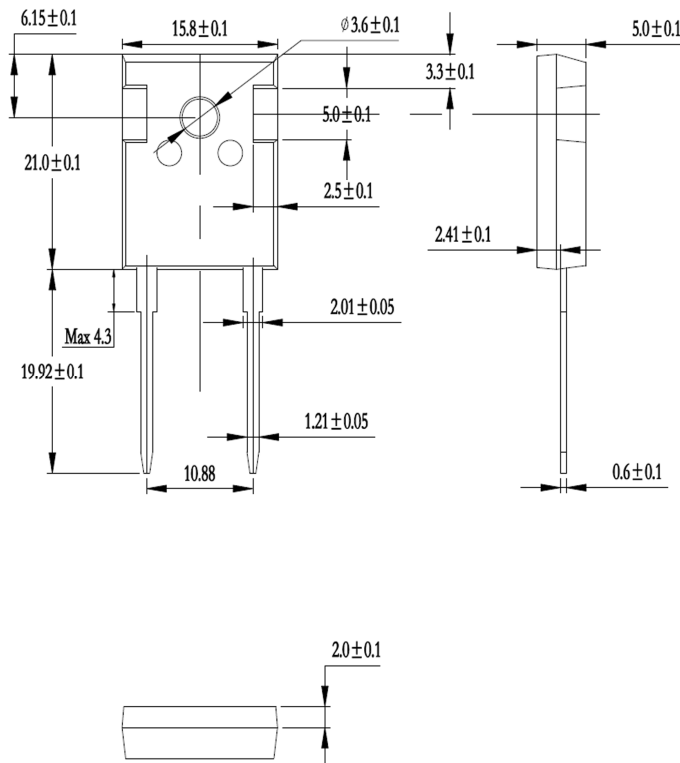

Figure 7. Diode Reverse Recovery Test Circuit and Waveform



Dimensions in (mm)  
Figure 8. Package Outline