

PRODUCT FEATURES

- Ultrafast Reverse Recovery Time
- Soft Reverse Recovery Characteristics
- Low Reverse Recovery Loss
- Low Forward Voltage
- High Surge Current Capability
- Low Inductance Package



APPLICATIONS

- Inversion Welder
- Uninterruptible Power Supply (UPS)
- Plating Power Supply
- Ultrasonic Cleaner and Welder
- Converter & Chopper
- Power Factor Correction (PFC) Circuit

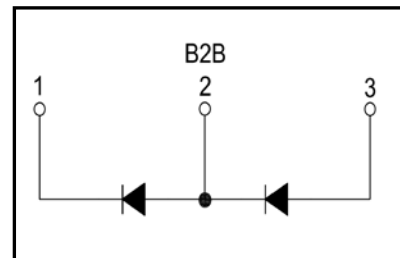

ABSOLUTE MAXIMUM RATINGS

$T_C=25^{\circ}\text{C}$ unless otherwise specified

Symbol	Parameter	Test Conditions	Values	Unit
V_R	Maximum D.C. Reverse Voltage		1700	V
V_{RRM}	Maximum Repetitive Reverse Voltage		1700	V
$I_{F(AV)}$	Average Forward Current	$T_C=80^{\circ}\text{C}$, Per Diode	100	A
		$T_C=80^{\circ}\text{C}$, 20KHz, Per Diode	75	A
$I_{F(RMS)}$	RMS Forward Current	$T_C=80^{\circ}\text{C}$, Per Diode	140	A
I_{FSM}	Non-Repetitive Surge Forward Current	$t=10\text{ms}$, 50Hz, Sine	1000	A
		$t=8.3\text{ms}$, 60Hz, Sine	1100	A
I^2t	I^2t (For Fusing)	$t=10\text{ms}$, 50Hz, Sine	5000	A^2s
		$t=8.3\text{ms}$, 60Hz, Sine	6050	A^2s
P_D	Power Dissipation		568	W
T_J	Junction Temperature		-40 to +150	$^{\circ}\text{C}$
T_{STG}	Storage Temperature Range		-40 to +125	$^{\circ}\text{C}$
V_{isol}	Insulation Test Voltage	AC, $t=1\text{min}$	3000	V
Torque	Module-to-Sink	Recommended (M6)	3~5	N·m
Torque	Module Electrodes	Recommended (M6)	3~5	N·m
$R_{\theta JC}$	Thermal Resistance	Junction-to-Case	0.22	$^{\circ}\text{C}/\text{W}$
Weight			160	g

ELECTRICAL CHARACTERISTICS

T_C=25°C unless otherwise specified

Symbol	Parameter	Test Conditions	Min.	Typ.	Max.	Unit
I _{RM}	Reverse Leakage Current	V _R =1700V	--	--	5	mA
		V _R =1700V, T _J =125°C	--	--	20	mA
V _F	Forward Voltage	I _F =100A	--	1.8	2.25	V
		I _F =100A, T _J =125°C	--	1.95	--	V
t _{rr}	Reverse Recovery Time	I _F =1A, V _R =30V, di _F /dt=-200A/μs	--	105	--	ns
t _{rr}	Reverse Recovery Time	V _R =850V, I _F =100A	--	500	--	ns
I _{RRM}	Max. Reverse Recovery Current	di _F /dt=-200A/μs, T _J =25°C	--	36	--	A
t _{rr}	Reverse Recovery Time	V _R =850V, I _F =100A	--	1.25	--	μs
I _{RRM}	Max. Reverse Recovery Current	di _F /dt=-200A/μs, T _J =125°C	--	42	--	A
t _{rr}	Reverse Recovery Time	V _R =850V, I _F =100A	--	450	--	ns
I _{RRM}	Max. Reverse Recovery Current	di _F /dt=-200A/μs, T _J =125°C	--	120	--	A

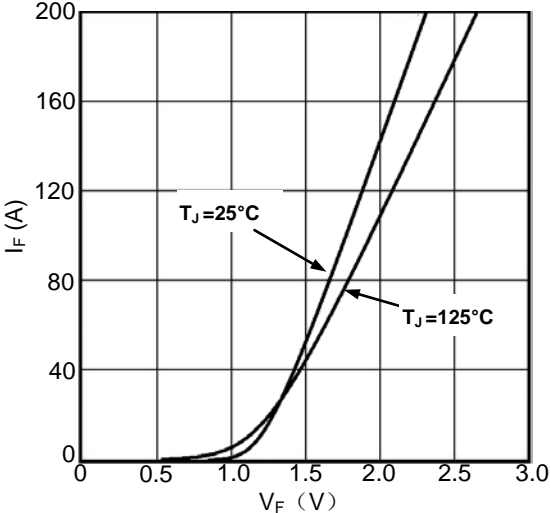

Figure1. Forward Voltage Drop vs Forward Current

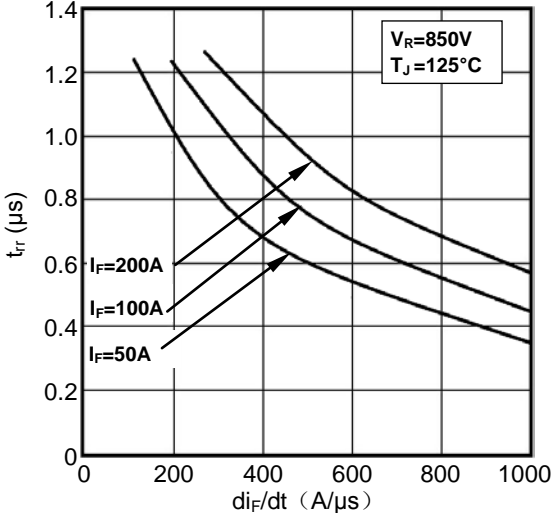

Figure2. Reverse Recovery Time vs di_F/dt

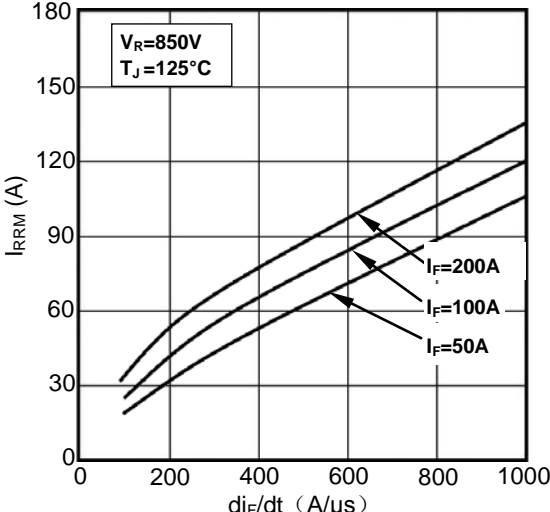

Figure3. Reverse Recovery Current vs di_F/dt

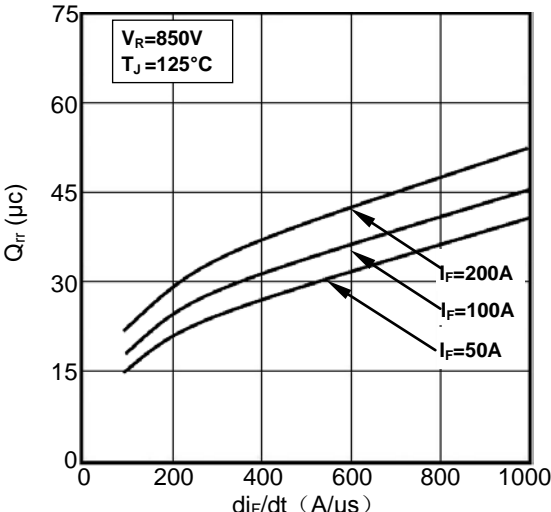

Figure4. Reverse Recovery Charge vs di_F/dt

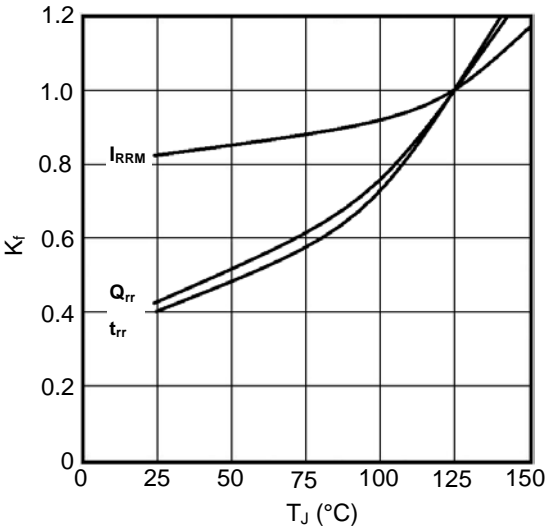

Figure5. Dynamic Parameters vs Junction Temperature

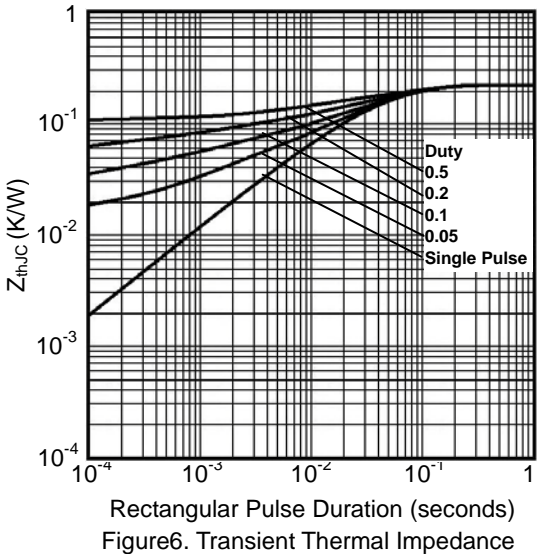
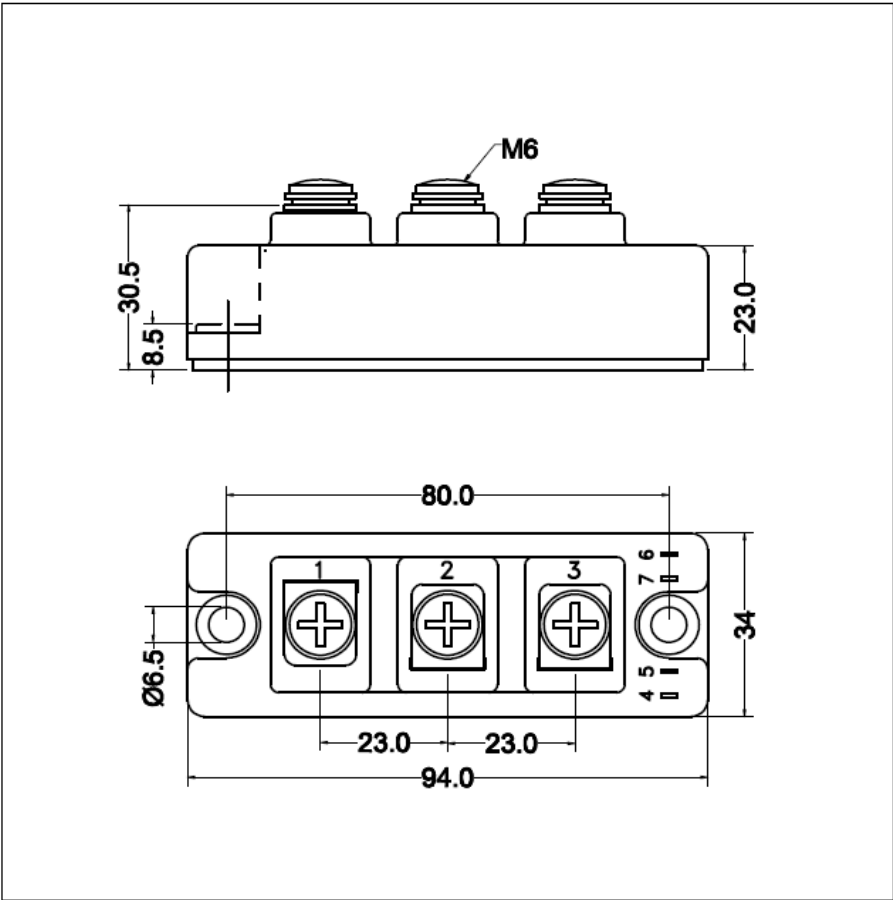

Figure6. Transient Thermal Impedance



Dimensions (mm)
Figure7. Package Outline