

PRODUCT FEATURES

- IGBT chip in trench FS-technology
- Low switching losses
- $V_{CE(sat)}$ with positive temperature coefficient
- Fast switching and short tail current
- Free wheeling diodes with fast and soft reverse recovery

APPLICATIONS

- Welding Machine
- Power Supplies
- Others



IGBT-inverter

ABSOLUTE MAXIMUM RATINGS ($T_C=25^\circ\text{C}$ unless otherwise specified)

| Symbol | Parameter/Test Conditions | Values | Unit |
|-----------|-----------------------------------|--|------|
| V_{CES} | Collector Emitter Voltage | $T_J=25^\circ\text{C}$ | V |
| V_{GES} | Gate Emitter Voltage | | |
| I_C | DC Collector Current | $T_C=25^\circ\text{C}, T_{Jmax}=175^\circ\text{C}$ | 75 |
| | | $T_C=95^\circ\text{C}, T_{Jmax}=175^\circ\text{C}$ | 50 |
| I_{CM} | Repetitive Peak Collector Current | $t_p=1\text{ms}$ | 100 |
| P_{tot} | Power Dissipation Per IGBT | $T_C=25^\circ\text{C}, T_{Jmax}=175^\circ\text{C}$ | 300 |

Diode-inverter

ABSOLUTE MAXIMUM RATINGS ($T_C=25^\circ\text{C}$ unless otherwise specified)

| Symbol | Parameter/Test Conditions | Values | Unit |
|-------------|---------------------------------|---|----------------------|
| V_{RRM} | Repetitive Reverse Voltage | $T_J=25^\circ\text{C}$ | V |
| $I_{F(AV)}$ | Average Forward Current | | A |
| I_{FRM} | Repetitive Peak Forward Current | $t_p=1\text{ms}$ | |
| I^2t | | $T_J=125^\circ\text{C}, t=10\text{ms}, V_R=0\text{V}$ | A^2S |

MacMic Science & Technology Co., Ltd.

Add: #18, Hua Shan Zhong Lu, New District, Changzhou City, Jiangsu Province, P. R. of China

MMG50S120B6UC

IGBT-inverter

ELECTRICAL CHARACTERISTICS ($T_C=25^\circ\text{C}$ unless otherwise specified)

| Symbol | Parameter/Test Conditions | | Min. | Typ. | Max. | Unit | |
|---------------|--|---|--|------|-------------|---------------|-------------|
| $V_{GE(th)}$ | Gate Emitter Threshold Voltage | $V_{CE}=V_{GE}, I_C=2\text{mA}$ | 5.0 | 5.6 | 6.4 | V | |
| $V_{CE(sat)}$ | Collector Emitter Saturation Voltage | $I_C=50\text{A}, V_{GE}=15\text{V}, T_J=25^\circ\text{C}$ | | 2.2 | 2.65 | | |
| | | $I_C=50\text{A}, V_{GE}=15\text{V}, T_J=125^\circ\text{C}$ | | 2.4 | | | |
| | | $I_C=50\text{A}, V_{GE}=15\text{V}, T_J=150^\circ\text{C}$ | | 2.45 | | | |
| I_{CES} | Collector Leakage Current | $V_{CE}=1200\text{V}, V_{GE}=0\text{V}, T_J=25^\circ\text{C}$ | | | 100 | μA | |
| | | $V_{CE}=1200\text{V}, V_{GE}=0\text{V}, T_J=150^\circ\text{C}$ | | | 1 | mA | |
| I_{GES} | Gate Leakage Current | $V_{CE}=0\text{V}, V_{GE}=\pm 20\text{V}, T_J=25^\circ\text{C}$ | -400 | | 400 | nA | |
| R_{gint} | Integrated Gate Resistor | | | 2 | | Ω | |
| Q_g | Gate Charge | $V_{CE}=600\text{V}, I_C=50\text{A}, V_{GE}=15\text{V}$ | | 0.28 | | μC | |
| C_{ies} | Input Capacitance | $V_{CE}=25\text{V}, V_{GE}=0\text{V}, f=1\text{MHz}$ | | 3.6 | | nF | |
| C_{res} | Reverse Transfer Capacitance | | | | 160 | | pF |
| $t_{d(on)}$ | Turn on Delay Time | $V_{CC}=600\text{V}, I_C=50\text{A}$ $R_G=15\Omega,$ $V_{GE}=\pm 15\text{V},$ Inductive Load | $T_J=25^\circ\text{C}$ | | 60 | ns | |
| | | | $T_J=125^\circ\text{C}$ | | 65 | ns | |
| | | | $T_J=150^\circ\text{C}$ | | 65 | ns | |
| t_r | Rise Time | | $T_J=25^\circ\text{C}$ | | 40 | ns | |
| | | | $T_J=125^\circ\text{C}$ | | 40 | ns | |
| | | | $T_J=150^\circ\text{C}$ | | 40 | ns | |
| $t_{d(off)}$ | Turn off Delay Time | $T_J=25^\circ\text{C}$ | | 250 | ns | | |
| | | $T_J=125^\circ\text{C}$ | | 290 | ns | | |
| | | $T_J=150^\circ\text{C}$ | | 310 | ns | | |
| t_f | Fall Time | $T_J=25^\circ\text{C}$ | | 70 | ns | | |
| | | $T_J=125^\circ\text{C}$ | | 100 | ns | | |
| | | $T_J=150^\circ\text{C}$ | | 110 | ns | | |
| E_{on} | Turn on Energy | $V_{CC}=600\text{V}, I_C=50\text{A}$ $R_G=15\Omega,$ $V_{GE}=\pm 15\text{V},$ Inductive Load | $T_J=125^\circ\text{C}$ | | 5.4 | mJ | |
| | | | $T_J=150^\circ\text{C}$ | | 5.9 | mJ | |
| E_{off} | Turn off Energy | | $T_J=125^\circ\text{C}$ | | 2.2 | mJ | |
| | | | $T_J=150^\circ\text{C}$ | | 2.4 | mJ | |
| I_{SC} | Short Circuit Current | | $t_{psc} \leq 10\mu\text{s}, V_{GE}=15\text{V}$ $T_J=150^\circ\text{C}, V_{CC}=600\text{V}$ | | 345 | | A |
| R_{thJC} | Junction to Case Thermal Resistance (Per IGBT) | | | | 0.5 | K/W | |

Diode-inverter

ELECTRICAL CHARACTERISTICS ($T_C=25^\circ\text{C}$ unless otherwise specified)

| Symbol | Parameter/Test Conditions | | Min. | Typ. | Max. | Unit |
|-------------|---|---|------|------|------|---------------|
| V_F | Forward Voltage | $I_F=50\text{A}, V_{GE}=0\text{V}, T_J=25^\circ\text{C}$ | | 2.1 | 2.6 | V |
| | | $I_F=50\text{A}, V_{GE}=0\text{V}, T_J=125^\circ\text{C}$ | | 1.85 | | |
| | | $I_F=50\text{A}, V_{GE}=0\text{V}, T_J=150^\circ\text{C}$ | | 1.80 | | |
| t_{rr} | Reverse Recovery Time | $I_F=50\text{A}, V_R=600\text{V}$ $dI_F/dt=-1750\text{A}/\mu\text{s}$ $T_J=150^\circ\text{C}$ | | 100 | | ns |
| I_{RRM} | Max. Reverse Recovery Current | | | 68 | | A |
| Q_{RR} | Reverse Recovery Charge | | | 7.2 | | μC |
| E_{rec} | Reverse Recovery Energy | | | 3 | | mJ |
| R_{thJCD} | Junction to Case Thermal Resistance (Per Diode) | | | | 1.05 | K/W |

MMG50S120B6UC

MODULE CHARACTERISTICS ($T_c=25^\circ\text{C}$ unless otherwise specified)

| Symbol | Parameter/Test Conditions | Values | Unit | |
|------------|-----------------------------|-------------------------------|------------------|----|
| T_{Jmax} | Max. Junction Temperature | 175 | $^\circ\text{C}$ | |
| T_{Jop} | Operating Temperature | -40~150 | | |
| T_{stg} | Storage Temperature | -40~125 | | |
| V_{isol} | Isolation Breakdown Voltage | AC, 50Hz(R.M.S), $t=1$ minute | 3000 | V |
| CTI | Comparative Tracking Index | | > 200 | |
| Torque | to heatsink | Recommended (M6) | 3~5 | Nm |
| | to terminal | Recommended (M5) | 2.5~5 | Nm |
| Weight | | | 160 | g |

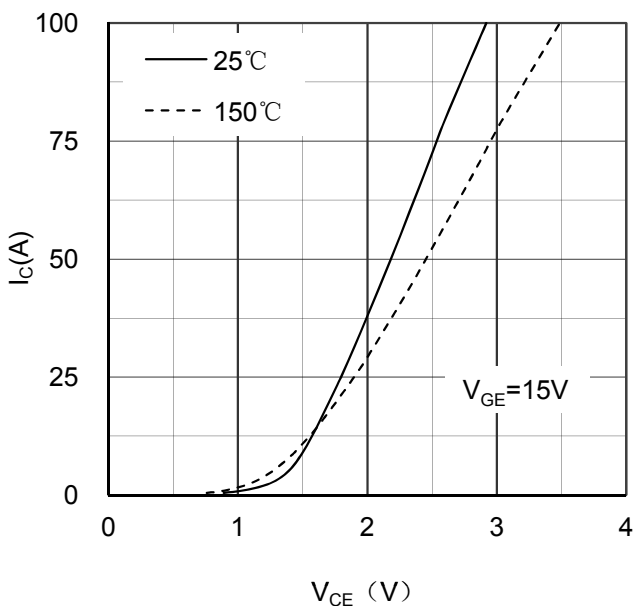

Figure 1. Typical Output Characteristics IGBT-inverter

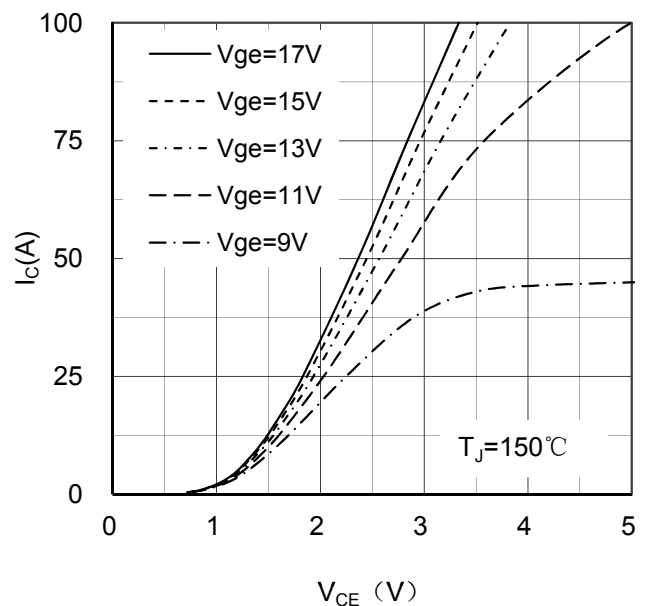

Figure 2. Typical Output Characteristics IGBT-inverter

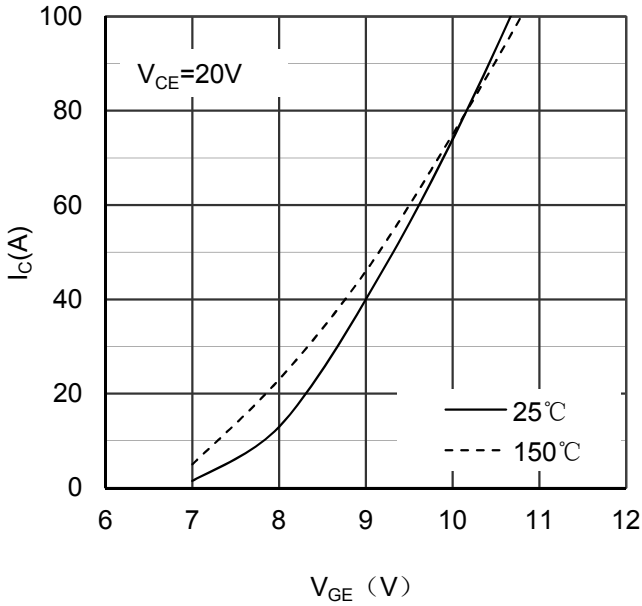

Figure 3. Typical Transfer characteristics IGBT-inverter

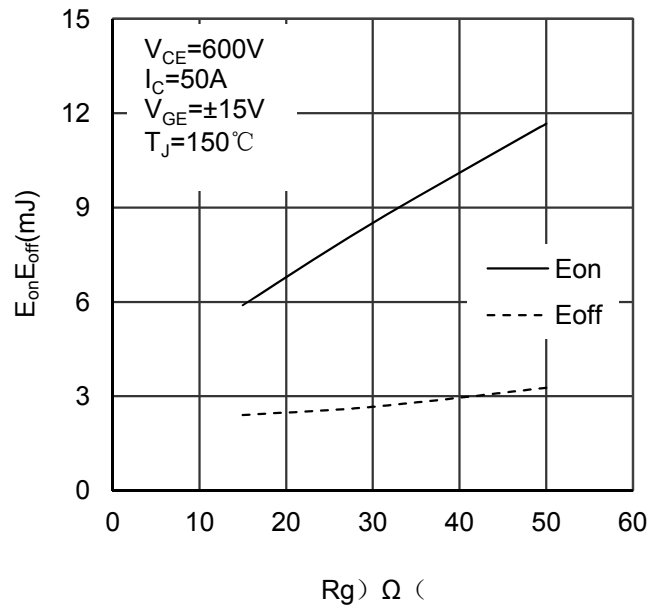

Figure 4. Switching Energy vs Gate Resistor IGBT-inverter

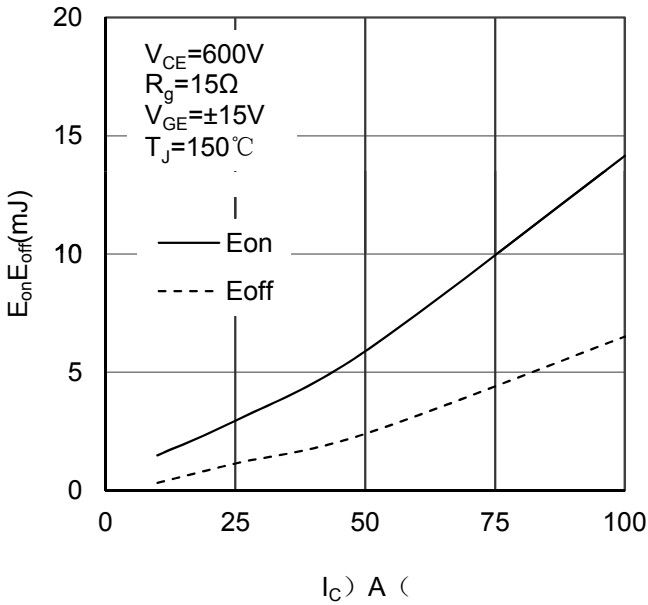

Figure 5. Switching Energy vs Collector Current IGBT-inverter

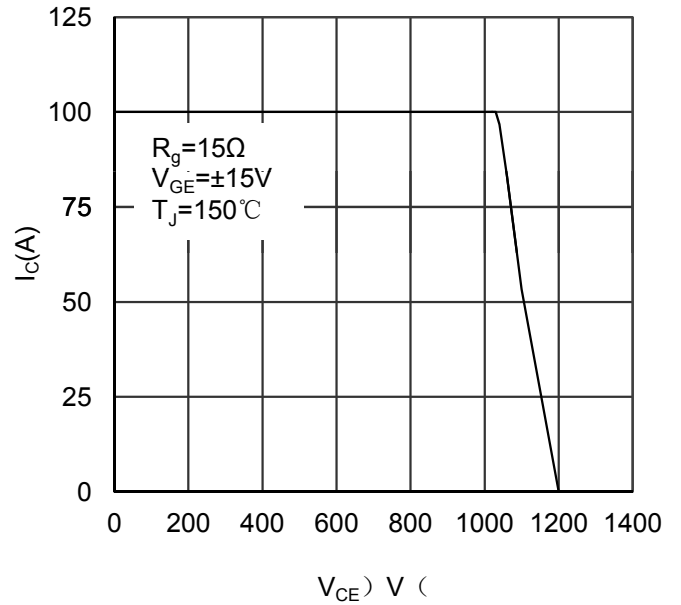

Figure 6. Reverse Biased Safe Operating Area IGBT-inverter

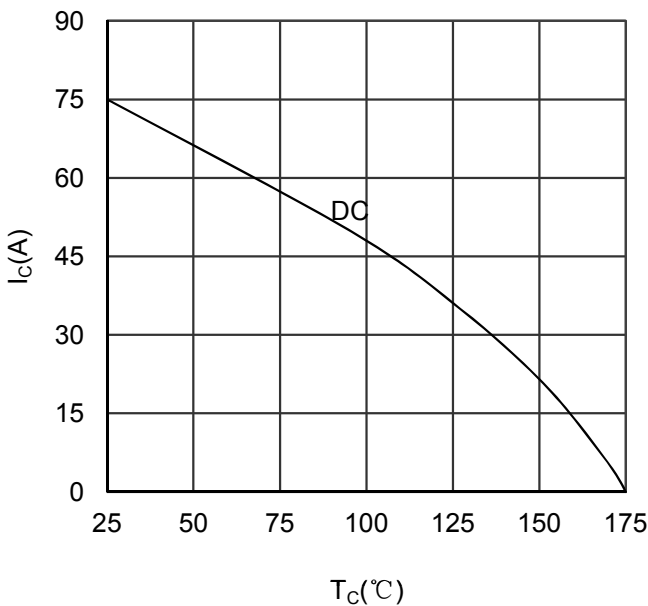

Figure 7. Collector Current vs Case temperature IGBT -inverter

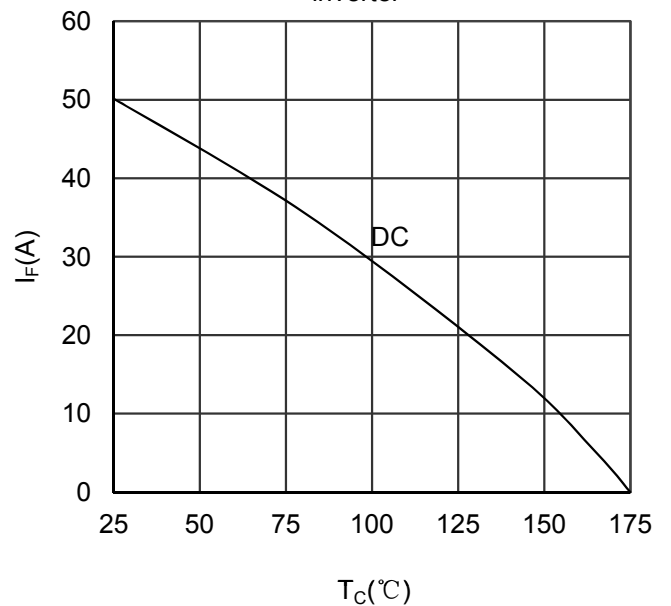

Figure 8. Forward current vs Case temperature Diode -inverter

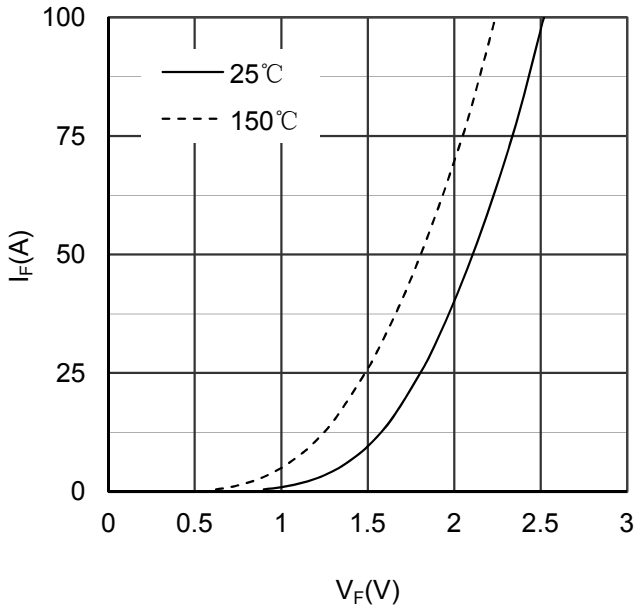

Figure 9. Diode Forward Characteristics Diode -inverter

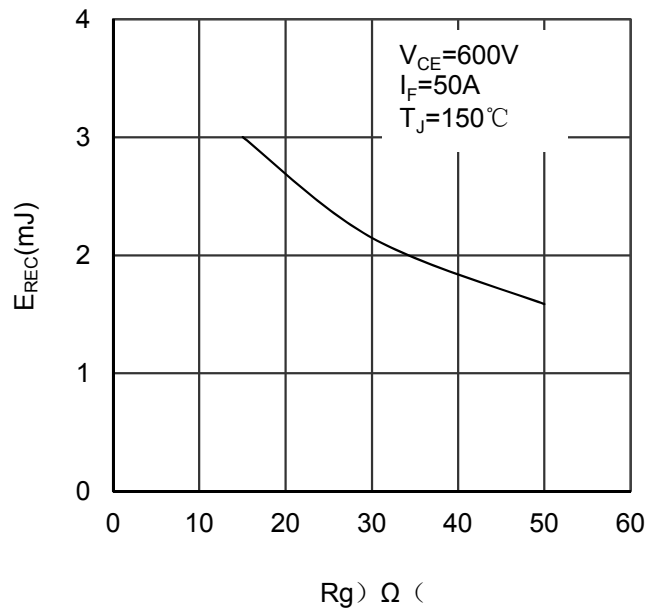

Figure 10. Switching Energy vs Gate Resistor Diode -inverter

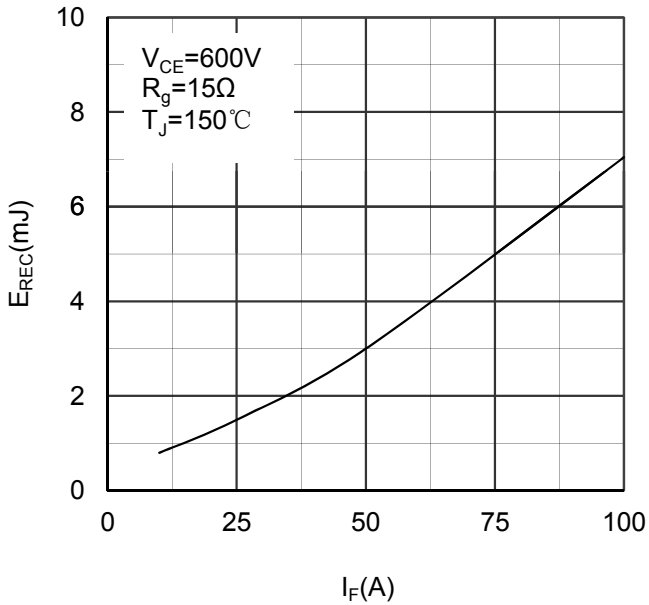

Figure 11. Switching Energy vs Forward Current Diode-inverter

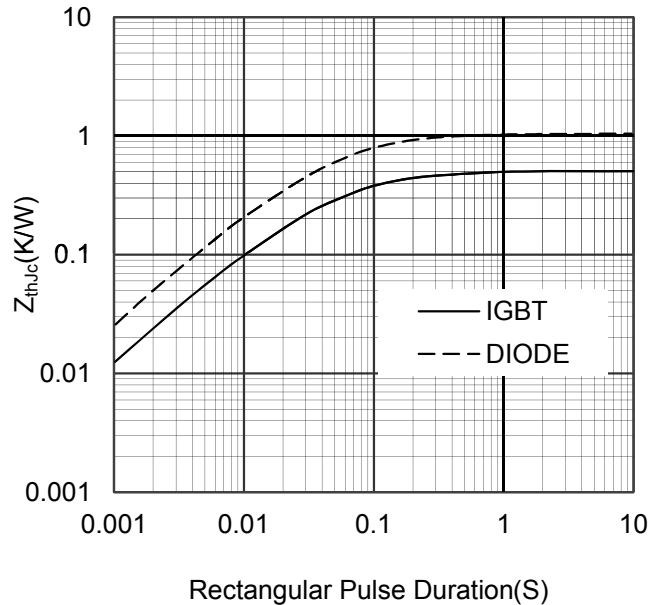

Figure 12. Transient Thermal Impedance of Diode and IGBT-inverter

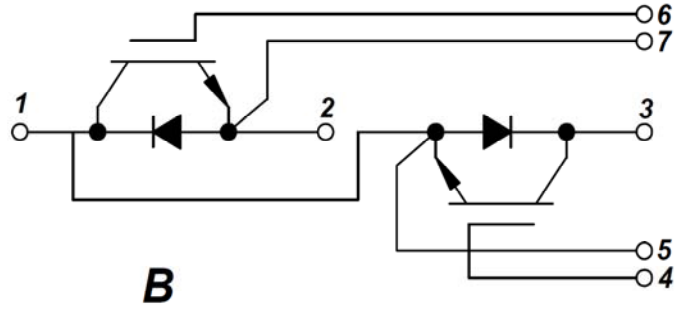
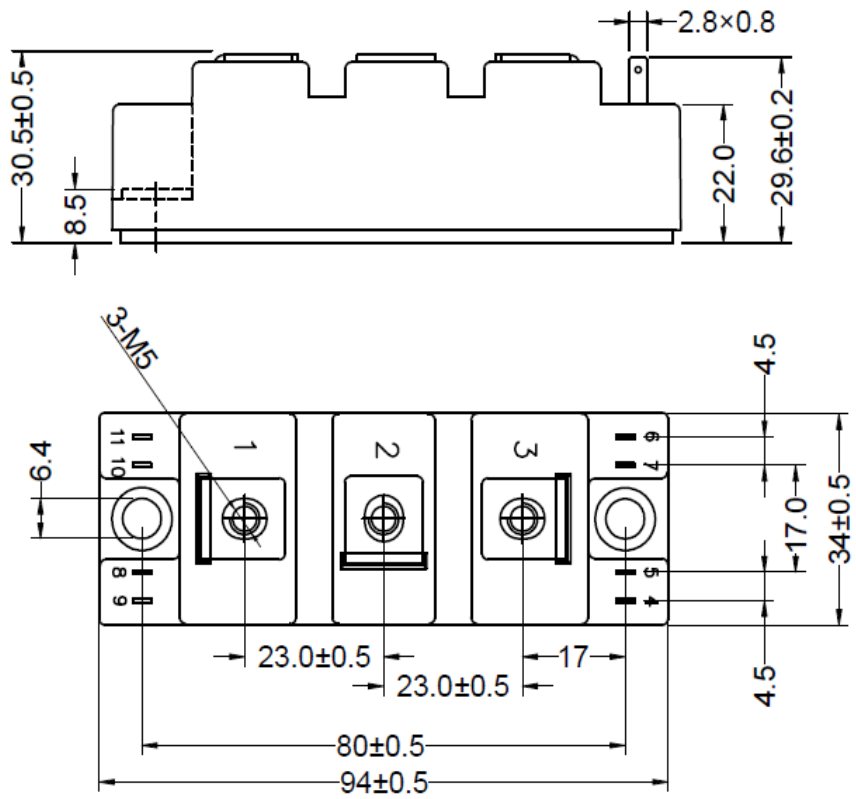

Figure 13. Circuit Diagram



Dimensions in (mm)
Figure 14. Package Outline